

# Conductivity controller

## Supmea

### Headquarters

5th floor, Building 4, Singapore Hangzhou Science Technology Park, No. 6 street,  
Hangzhou Economic Development Area, Hangzhou 310018, China

### Singapore

2 Venture Drive #11-30 Vision Exchange Singapore

✉ [info@supmea.com](mailto:info@supmea.com)

🌐 [www.supmea.com](http://www.supmea.com)

Supmea Automation Co., Ltd.

---

## **Preface**

Thank you for purchasing Conductivity controller. Please read this manual carefully before operating and using it correctly to avoid unnecessary losses caused by false operation.

### **Note**

- Modification of this manual's contents will not be notified as a result of some factors, such as function upgrading.
- We try our best to guarantee that the manual content is accurate, if you find something wrong or incorrect, please contact us.
- This product is forbidden to use in explosion-proof occasions.

### **Version**

U-SUP-TDS210-B/TDS210-C-EN5

---

## **Safety Precautions**

In order to use this product safely, be sure to follow the safety precautions described.

### **About this manual**

- Please submit this manual to the operator for reading.
- Please read the operation manual carefully before applying the instrument. On the precondition of full understanding.
- This manual only describes the functions of the product. The company does not guarantee that the product will be suitable for a particular use by the user.

### **Precautions for protection, safety and modification of this product**

- To ensure safe use of this product and the systems it controls, Please read carefully the operation manual and understand the correct application methods before putting into operation, to avoid unnecessary losses due to operation mistakes. If the instrument is operated in other ways not described in the manual, the protections that the instrument give may be destroyed, and the failures and accidents incurred due to violation of precautions shall not be borne by our company.
- When installing lightning protection devices for this product and its control system, or designing and installing separate safety protection circuits for this product and its control system, it needs to be implemented by other devices.
- If you need to replace parts of the product, please use the model specifications specified by the company.
- This product is not intended for use in systems that are directly related to personal safety. Such as nuclear power equipment, equipment using radioactivity, railway systems, aviation equipment, marine equipment, aviation equipment and medical equipment. If applied, it is the responsibility of the user to use additional equipment or systems to ensure personal safety.

- 
- Do not modify this product.
  - The following safety signs are used in this manual:



Hazard, if not taken with appropriate precautions, will result in serious personal injury, product damage or major property damage.



Warning: Pay special attention to the important information linked to product or particular part in the operation manual.



- Confirm if the supply voltage is consistent with the rated voltage before operation.
- Don't use the instrument in a flammable and combustible or steam area.
- To prevent from electric shock, operation mistake, a good grounding protection must be made.
- Thunder prevention engineering facilities must be well managed: the shared grounding network shall be grounded at is-electric level, shielded, wires shall be located rationally, SPD surge protector shall be applied properly.
- Some inner parts may carry high voltage. Do not open the square panel in the front except our company personnel or maintenance personnel acknowledged by our company, to avoid electric shock.
- Cut off electric powers before making any checks, to avoid electric shock.
- Check the condition of the terminal screws regularly. If it is loose, please tighten it before use.
- It is not allowed to disassemble, process, modify or repair the product without authorization, otherwise it may cause abnormal operation, electric shock or fire accident.
- Wipe the product with a dry cotton cloth. Do not use alcohol, benzene or other organic solvents. Prevent all kinds of liquid from splashing on the

---

product. If the product falls into the water, please cut off the power immediately, otherwise there will be leakage, electric shock or even a fire accident.

- Please check the grounding protection status regularly. Do not operate if you think that the protection measures such as grounding protection and fuses are not perfect.
- Ventilation holes on the product housing must be kept clear to avoid malfunctions due to high temperatures, abnormal operation, shortened life and fire.
- Please strictly follow the instructions in this manual, otherwise the product's protective device may be damaged.



- Don't use the instrument if it is found damaged or deformed at opening of package.
- Prevent dust, wire end, iron fines or other objects from entering the instrument during installation, otherwise, it will cause abnormal movement or failure.
- During operation, to modify configuration, signal output, startup, stop, operation safety shall be fully considered. Operation mistakes may lead to failure and even destruction of the instrument and controlled equipment.
- Each part of the instrument has a certain lifetime, which must be maintained and repaired on a regular basis for long-time use.
- The product shall be scrapped as industrial wastes, to prevent environment pollution.
- When not using this product, be sure to turn off the power switch.
- If you find smoke from the product, smell odor, abnormal noise, etc., please turn off the power switch immediately and contact the company in time.

---

## Disclaimer

- The company does not make any guarantees for the terms outside the scope of this product warranty.
- This company is not responsible for damage to the instrument or loss of parts or unpredictable damage caused directly or indirectly by improper operation of the user.

## Package contents

| No. | Name                    | Quantity | Note |
|-----|-------------------------|----------|------|
| 1   | Conductivity controller | 1        |      |
| 2   | Manual                  | 1        |      |
| 3   | Certificate             | 1        |      |

After opening the box, please confirm the package contents before starting the operation. If you find that the model and quantity are incorrect or there is physical damage in appearance, please contact us.

---

## Contents

|                                      |    |
|--------------------------------------|----|
| Chapter 1 Introduction.....          | 1  |
| 1.1. Characteristic.....             | 1  |
| 1.2. Technical Parameters.....       | 2  |
| Chapter 2 Installation.....          | 3  |
| 2.1. Instrument installation.....    | 3  |
| 2.2. Electrode installation.....     | 6  |
| 2.3. Wiring.....                     | 7  |
| Chapter 3 \Navigation keys.....      | 8  |
| Chapter 4 System menu.....           | 10 |
| 4.1. EC Monitoring page.....         | 10 |
| 4.2. TDS Monitoring page.....        | 10 |
| 4.3. Password verification page..... | 11 |
| 4.4. Page of main menu.....          | 11 |
| 4.5. System Setting page.....        | 12 |
| 4.6. Signal Setting page.....        | 12 |
| 4.7. Remote setting page.....        | 13 |
| 4.8. Alarm Setting page.....         | 14 |
| 4.9. Information inquiry page.....   | 14 |
| Chapter 5 Communication.....         | 15 |
| Chapter 6 Troubleshooting.....       | 19 |

## Chapter 1 Introduction

Conductivity controller is widely used in thermal power, chemical fertilizer, metallurgy, environmental protection, pharmaceutical, biochemical, food and tap water industries, etc. The controller mainly continuously monitors the conductivity/total dissolved solids/resistivity and temperature in the solution.

### 1.1. Characteristic

- 4-20mA isolated transmission output, which is less affected by interference
- RS485 communication (MODBUS-RTU protocol)
- Manual and auto temp compensation
- High/low alarm (relay)
- Buzzer/LCD backlight switch



## 1.2. Technical Parameters

|                                |  |
|--------------------------------|--|
| Screen size                    | 2.8 inch   |
| Dimension                      | Overall dimension: 100mm*100mm*150mm(H*W*D)<br>Cutout dimension: 92.5mm*92.5mm(H*W)  |
| Weight                         | 0.65Kg   |
| Measure variables              | EC/TDS/ER  |
| Measure range                  | (It is not recommended to use in 1us/cm pure water.)<br>0.01 electrode: 0~20.00μS/cm/ 0.05 ~ 20.00MΩ*cm<br>0.1 electrode: 0.20~200.0μS/cm<br>1.0 electrode: 2.00~2000μS/cm, maximum 20000uS/cm<br>10.0 electrode: 0.02~20.00mS/cm<br>Temperature range: -10~130℃ |
| Temperature compensation       | NTC10K/PT1000<br>Temperature compensation: manual/automatic  |
| Accuracy                       | 2%   |
| Basic error of electronic unit | EC/TDS/ER: ±1%FS<br>NTC10K: ±0.3℃<br>PT1000: ±0.3℃   |
| Output                         | Isolated,(4 ~ 20)mA,<br>maximum loop is 750Ω, ±0.2%FS  |
| Communication protocol         | Isolated, MODBUS-RTU RS485   |
| Alarm                          | 2 relay, AC250V/ 3A  |
| Relative humidity              | (10~85)%RH(No condensation)  |
| Operating temperature          | (0~60)℃  |
| Power supply                   | 220VAC±10% 50Hz/60Hz   |
| Storage conditions             | Temperature: (-15~65)℃<br>Relative humidity: 5~95%RH(No condensation)  |

## Chapter 2 Installation

### 2.1. Instrument installation

The installation location and method of the instrument are explained, the part shall be carefully read during the installation.

#### Notes for installation

- The instrument is panel mounted.
- It shall be installed inside the building so as to avoid wind and rain as well as direct sunlight.
- Please install it at the place with good ventilation in order to prevent the internal temperature of the instrument from rising.
- Don't lean to left or right when the instrument is installed, horizontal installation shall be realized as possible.

#### The following places shall be avoided during the installation

- The place where the environment temperature exceeds 60°C during the operation.
- The place where the environment humidity exceeds 85% during the work.
- The vicinity of the electromagnetic occurring sources.
- The sites with strong mechanical vibration.
- The site where the temperature is changed a lot and the moisture condensation is easily formed.
- Places with lots of lampblack, steam, moisture, dust and corrosive gas.

**Installation**

Install a 92.5 \* 92.5 mounting hole on the instrument cabinet or mounting panel,  
The thickness of the installation panel is 1.5mm~13mm.

**★ Dimension of TDS210-B**

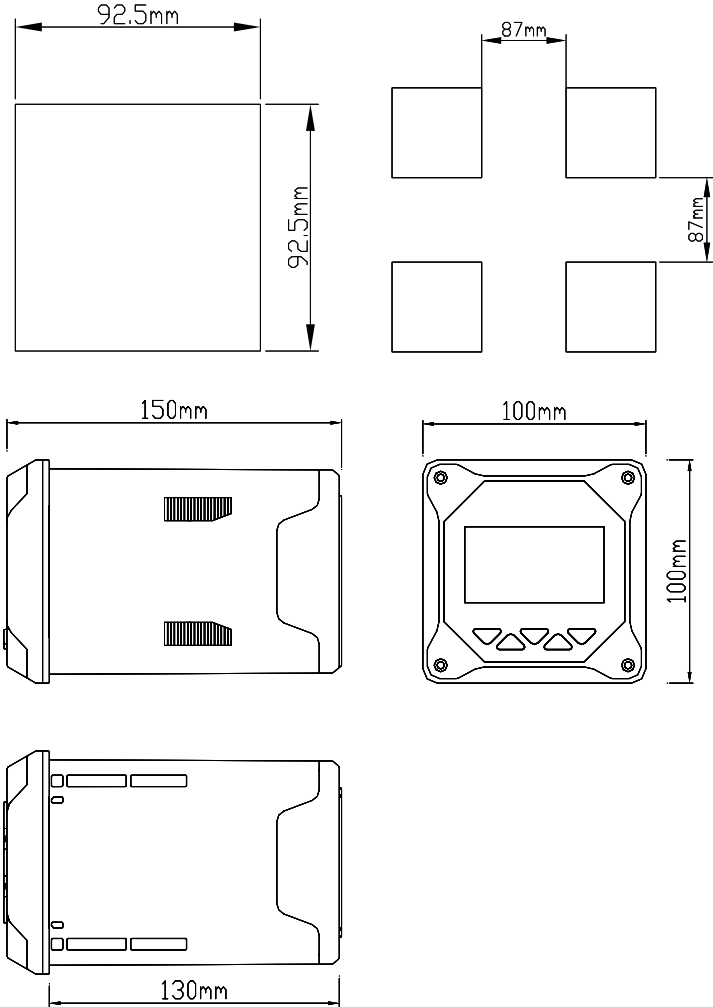

★ Dimension of TDS210-C

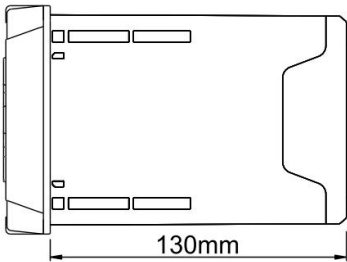
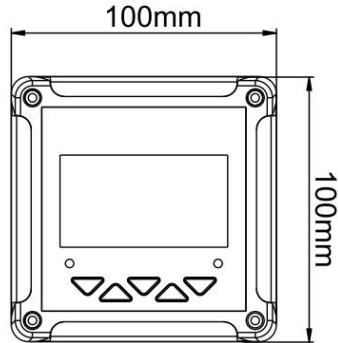
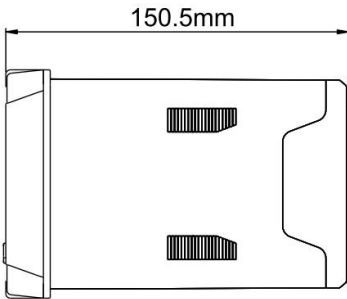
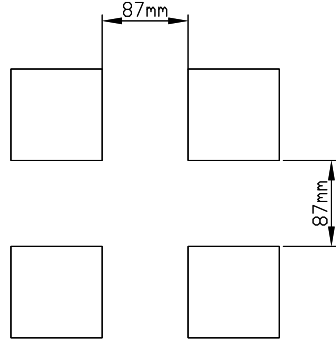
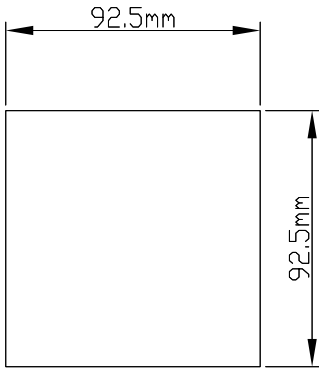

The instrument into the mounting hole and then buckle on the Snap, as shown below

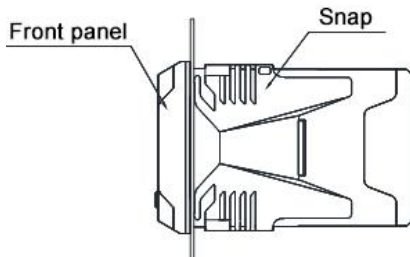

TDS210-B

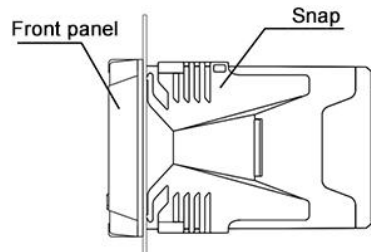

TDS210-C

## 2.2. Electrode installation

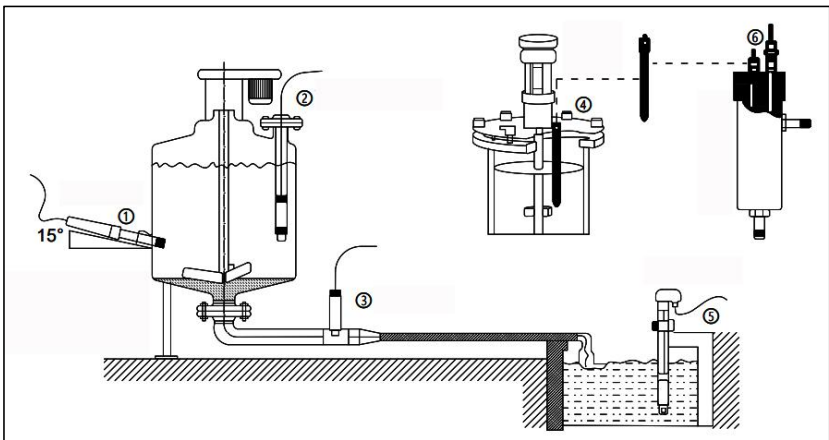

Schematic diagram of common installation method

- ①Side wall installation ②Flange mounted at the top ③Pipe installation ④To p installation ⑤Submersible installation ⑥Flow-through installation

The interface must be in 15° oblique angle, or it will affect the normal test and use of the electrode. We won't be responsible for any results due to this.

## 2.3. Wiring

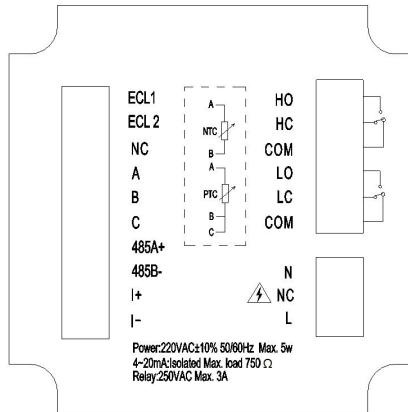

Wiring diagram

### Terminal assignment

- ECL1: Conductivity electrode+
- ECL2: Conductivity electrode-
- NC: Unidentified
- A: Temperature compensation terminal A, NTC10K or PT1000A
- B: Temperature compensation terminal B, NTC10K or PT1000B
- C: Temperature compensation terminal C, PT1000 three-wire temperature grounding, PT1000 two-wire need to be short-connected to TEMPB, When connected to NTC10K, C terminal is not connected.
- 485A + : RS485 communication interface A +
- 485B - : RS485 communication interface B -
- I + : 4~20mA output +
- I - : 4~20mA output -
- HO: High alarm normally open
- HC: High alarm normally closed
- COM: High alarm common terminal
- LO: Low alarm normally open
- LC: Low alarm normally closed
- COM: Low alarm common terminal
- N: AC220V neutral wire
- NC: Unidentified
- L: AC220V live wire

### Chapter 3 \Navigation keys









★ TDS210-B



★ TDS210-C

Table 1 Definition of buttons

| Sign | Button name | Function description  |
|------|-------------|---|
|      | ESC         | Under "Monitoring page" - Alarm view<br>Under "Menu page" - Return to the previous page     |
|      | RIGHT       | Enter the menu under "monitoring interface"<br>Exit the menu under "monitoring interface"   |
|      | MENU        | Enter the MENU on the "monitoring page"<br>Exit the MENU on the "menu page"                 |
|      | DOWN        | Under "menu page" - Select the related menu<br>Modify the values in the configuration state |
|      | ENTER       | Under "Menu page" - Enter the sub-menu or confirm modification                              |

|   |                 |   |
|---|-----------------|---|
| <br>+<br> | SHORTCUT<br>KEY | Press and hold to enter the online calibration function interface         |
| <br>+<br> | SHORTCUT<br>KEY | Press and hold to enter the alarm setting function interface              |
| <br>+<br> | SHORTCUT<br>KEY | Press and hold to enter the electrode constant setting function interface |



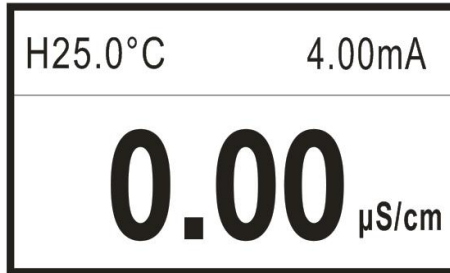

## Chapter 4 System menu

### 4.1. EC Monitoring page

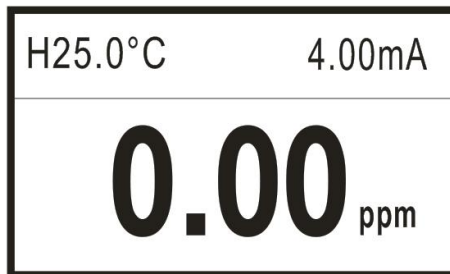

### 4.2. TDS Monitoring page



- Push  to enter password verification page, input password to enter the home page.
- Push  to enter alarm inquiry page, to inquire the current warning

### 4.3. Password verification page

----- User Password -----  
Password: 0000

- The initial password 0000, if you need to change it, please use the password modification function.
- If you forget your password, please contact us for more information.

### 4.4. Page of main menu

----- Main Menu -----  
1. System Setting  
2. Signal Setting  
3. Remote Setting  
4. Alarm Setting  
5. Information Inquiry

- System Setting: settings of language, buzzer and backlight, modification of password and factory settings.
- Signal Setting: constant of electrode, online calibration, unit switch, TDS coefficient, temperature correction, temperature coefficient and temperature compensation switch.
- Remote Setting: settings of RS485 parameters and 4~20mA transmission output.
- Alarm Setting: settings of parameters of high and low warning.
- Information Inquiry: current version number.

#### 4.5. System Setting page

----- System Setting -----

1. Language
2. Buzzer
3. Backlight setting
4. Change password
5. Factory setting



- Language: Chinese or English.
- Buzzer: ON/OFF setting.
- Backlight :ON/OFF setting of monochrome LCD screen
- Change Password: password modification and log-in with new password.
- Factory setting: return to factory settings.

#### 4.6. Signal Setting page

----- Signal Setting -----

1. Electrode Constant
2. Online Calibration
3. Unit Switch
4. TDS Coefficient
5. Temp Switch
6. Temp Modification
7. Temp Coefficient

- Electrode constant: electrode constant, normally of 4 types: 0.01, 0.1, 1.0, 10.0.
- Online calibration: single point calibration of any standard solution can be carried out. First, set the temperature compensation mode to automatic compensation or manual compensation (the temperature has a great

impact on the accuracy during calibration), then enter the conductivity calibration input interface and input the calibration solution value to be calibrated (common standard solutions are 147.0  $\mu\text{s/cm}$ , 1413  $\mu\text{s/cm}$  and 12.88ms/cm, which can be calibrated according to the field standard), press  to enter the conductivity calibration interface, and then put the connected electrode into the standard solution. After the indication is stable, press  to calibrate. (press  to clear the calibration value, and the calibration range is 0.5 ~ 1.5 times of the standard solution value)

- Unit switch: The unit can be switched to ppm,  $\mu\text{s/cm}$  or  $\text{m}\Omega \cdot \text{cm}$ . When switching to ppm, TDS of solution is measured; when  $\mu\text{s/cm}$  is switched, conductivity (EC) of solution is measured; when  $\text{m}\Omega \cdot \text{cm}$  is switched, resistivity (ER) of solution is measured.
- TDS Coefficient: The conversion coefficient of conductivity and total dissolved solids, 0.5 by default, and the setting range is 0.4 ~ 1.0.
- Temp Switch: auto temperature compensation NTC10K or PT1000 or manual temperature compensation, temperature range:-10 $^{\circ}\text{C}$ ~130.0 $^{\circ}\text{C}$ .
- Temp Modification: the temperature value of automatic temperature compensation can be corrected within  $\pm 20.0^{\circ}\text{C}$ .
- Temp Coefficient: temperature compensation coefficient, 0.02 as default, and the setting range is 0.00 ~ 0.03.

#### 4.7. Remote setting page

----- Remote setting -----

1. RS485 setting
2. Current Transmission

- RS485 setting: settings of 485 communication address (1 ~254)and baud rate(2400,4800,9600,19200)bps.

- Current transmission: settings of 4mA corresponding value and 20mA corresponding value of 4-20mA output.

#### 4.8. Alarm Setting page

----- Alarm Setting -----

1. High Relay
2. Low Relay

- High alarm relay: set the pull in value and off value of high alarm relay.
- Low alarm relay: set the pull in value and off value of low alarm relay.
- The alarm signal type will be automatically selected according to the current measured signal value. After setting, the alarm information will not be cleared due to the change of the measurement signal type. The alarm value of the same signal type only needs to be set once.

#### 4.9. Information inquiry page

----- Information inquiry -----

Hardware Version  
B-EC6S1-V100  
Software Version  
Hex-EC6M1-V100

- Information inquiry: inquire the current version of hardware

## Chapter 5 Communication

The instrument is provided with standard RS485 series communication interface, in accordance with international universal standard MODBUS-RTU communication protocol, supporting No.03 register reading and holding command, 06 writing single register command

Modbus standard format

Table 2 Command format

| Definition      | Address | Function code | Register address | Number of data | CRC check |
|-----------------|---------|---------------|------------------|----------------|-----------|
| Data            | ADDR    | 0x03          | M                | N              | CRC 16    |
| Number of bytes | 1       | 1             | 2                | 2              | 2         |

Table 3 Return format

| Definition      | Address | Function code | Data size | Data | CRC check |
|-----------------|---------|---------------|-----------|------|-----------|
| Data            | ADDR    | 0x03          | 2*N       | Data | CRC 16    |
| Number of bytes | 1       | 1             | 1         | 2*N  | 2         |

Table 4 Register address description

| Address | Data type     | Data size | Function code | Description   | Access authority |
|---------|---------------|-----------|---------------|---|------------------|
| 0x0000  | unsigned long | 4 bytes   | 0x03          | Actual values of conductivity, resistivity and TDS (unit: $\mu s / cm$ , $m \Omega * cm$ , ppm, to be divided by 100) | Read only        |
| 0x0002  | short         | 2 bytes   | 0x03          | Temperature value (unit: $^{\circ}C$ , to be divided by 10)   | Read only        |
| 0x0003  | unsigned char | 1 byte    | 0x03/0x06     | 03 is read, 06 is the write function code, the  | Read/Write       |

|        |               |        |           |  |            |
|--------|---------------|--------|-----------|--|------------|
|        |               |        |           | communication address range is 1-254, and the default is 1                       |            |
| 0x0004 | unsigned char | 1 byte | 0x03/0x06 | 03 for read, 06 for write function code, 0 = 2400, 1 = 4800, 2 = 9600, 3 = 19200 | Read/Write |

**Example of conductivity reading**

Computer sends:                01 03 00 00 00 02 C4 0B

Conductivity meter returns: 01 03 04 00 00 12 34 5B 3C

Return command annotation:

- 01 is the address of slave, which can be configured in the instrument;
- 03 is function code, reading and holding register;
- 04 is the length of data of returned conductivity value, 4 bytes;
- 00 00 12 34 is the returned conductivity value, 4.96us/cm, unit: us/cm. The current conductivity value is obtained by dividing the value by 100, range: 0.00~60000.00us/cm.
- 5B3C is the CRC16 check code, which is varying depending on different data;

**Example of baud rate writing**

Computer sends:                01 06 00 04 00 02 09 CB

Command sends:

- 01 is the address of slave, which can be configured in the instrument;
- 06 is function code, writing register;
- 00 04 is the baud rate register address
- 00 02 is set to 9600 baud rate
- 09CB is the CRC16 check code, which is varying depending on different data;

Conductivity meter returns: 01 06 00 04 00 02 09 CB

If the return code value is consistent with the sending code value, the setting is successful.

### Example of temperature reading

Computer sends: 01 03 00 02 00 01 24 1B

Conductivity meter returns: 01 03 02 00 FA 98 0D

Return command annotation:

01 is the address of slave, which can be configured in the instrument;

03 is function code, reading and holding register;

02 is the length of data of returned temperature value, 2 bytes;

0FA is the returned temperature value, 25.0°C. The current temperature value is obtained by dividing the value by 10, range: -10.0 ~ 130.0°C

980D is the CRC16 check code, which is varying depending on different data.

### Response format of error return code:

| Exception code | Name                  | Description  |
|----------------|-----------------------|--|
| 01H            | Illegal function code | The slave receives an executable function code   |
| 02H            | Illegal data address  | 1. The address of the data cannot be recognized by the slave<br>2. The combined address of data address and data quantity is invalid |
| 03H            | Illegal data value    | 1. The amount of data is out of range<br>2. Data length error<br>3. Illegal data value   |



**Example of error return code:**

Computer sends: 01 03 00 05 00 02 C4 0B

Conductivity meter returns: 01 83 02 C0 F1

Error return code comments:

01 Slave address

83 0x80 + the function code issued by the host. If the function code issued by the host is 01, the function code of the exception response is 0x81; if the function code issued by the host is 03, the function code of the exception response is 0x83

02 exception code indicates, 02 as shown in the above table, represents the following two kinds of errors:

1. The address of the data cannot be recognized by the slave
2. The combined address of data address and data quantity is invalid

C0f1 is a CRC16 check code, which is varying depending on different data;

## Chapter 6 Troubleshooting

- No display at the controller?  
Solution: check if the power supply is correctly connected.
- Fluctuation of the displayed value?  
Solution: check if there are frequency converters and other interference equipment at the surrounding environment, notice to keep away from these interference equipment or adopt shield measures.
- Conductivity controller can not be calibrated?  
Solution: the standard solution preparation is not correct or the electrode is damaged.
- The instrument can not measure accurately after calibration with a standard solution of conductivity of 1413us/cm?  
Solution:if the standard solution is contaminated, exchange the standard solution for calibration again.
- The response of the figure is slow?  
Solution:the electrode is covered by dirt, the response will become slow, please clean according to the corresponding methods based on the types of the pollutants, it's normal phenomenon if it's slow in winter.
- Max value displayed?  
Solution:When it show the Max value on the display,the measurement value is over range.

## **Chapter 7 Warranty & After-sales Service**

We promise to the customer that the hardware accessories provided during the supply of the instrument have no defects in material and manufacturing process. From the date of the purchase, if the user's notice of such defects is received during the warranty period, the company will unconditionally maintain or replace the defective products without charge, and all non customized products are guaranteed to be returned and replaced within 7 days.

Disclaimers:

- During the warranty period, product faults caused by the following reasons are not in the scope of Three Guarantees service
- Product faults caused by improper use by customers.
- Product faults caused by disassembling, repairing and refitting the product.

After-sales service commitment:

- We promise to deal with the customer's technical questions within 2 hours.
- For the instruments returned to the factory for maintenance, we promise to issue the test results within 3 working days and the maintenance results within 7 working days after receiving them.